

IMPROVED LAUNCH INSTRUCTIONS

Please replace any previous versions with this manual

_maverick

Full-HD Camera Drone with GPS & WiFi

DRONE USER MANUAL



ZERO-X[®]

Capture the skies.™

CONTENTS

1.0	WELCOME	04
1.1	BEFORE YOU GET UP IN THE AIR	04
1.2	GENERAL SAFETY	04
1.3	BATTERY SAFETY	05
2.0	PACKAGE CONTENTS	06
2.1	MAVERICK OVERVIEW	06
2.2	CONTROLLER OVERVIEW	07
3.0	SETTING UP YOUR ZERO-X MAVERICK	08
3.1	CHARGING THE BATTERY	08
3.2	INSTALLING THE BATTERY	09
3.3	CHARGING THE CAMERA BATTERY	09
3.4	SECURING THE MAVERICKS LEGS	10
3.5	SECURING THE MAVERICKS BLADES	10
4.0	REMOTE CONTROL	12
4.1	INSTALLING A MICRO SD CARD	12
5.0	LAUNCH SEQUENCE	13
5.1	CALIBRATING THE MAVERICK	14
5.2	QUICK LAUNCH	18

6.0	BASIC FLIGHT	20
6.1	SPEED MODES.....	20
6.2	TRIMMING	21
6.3	GPS.....	22
6.4	RETURN TO HOME.....	22
6.5	DIRECTIONAL LOCK MODE	23
6.6	EMERGENCY LANDING	24
7.0	CAMERA	24
7.1	CAMERA INSTALLATION.....	25
7.2	RECORDING VIDEO	25
7.3	REVIEWING VIDEO	25
7.4	WIFI.....	26
7.5	MOUNTING YOUR SMART PHONE	27
8.0	DRONE MAINTENANCE	27
8.1	REPLACEMENT PARTS.....	27
9.0	WARRANTY TERMS & CONDITIONS	28
	NOTES	29

1.0 WELCOME

Thanks for purchasing a Zero-X Maverick, get ready to have the time of your life! We're sure your Zero-X Maverick will bring you a world of great experiences in the air. Please take the time to read the following safety warnings and operating instructions carefully.

1.1 BEFORE YOU GET UP IN THE AIR

Connect the Maverick battery to the included USB charging cable and insert the USB charging cable into the supplied USB wall charger. While the battery is charging please take the time to read the instructions and familiarise yourself with the controls of your Zero-X Maverick.

1.2 GENERAL SAFETY

Please familiarise yourself with your local legislation regarding drone usage before you begin using your Zero-X Maverick. Included in the package contents of your Zero-X Maverick are the Australian CASA guidelines, please read carefully and understand this information as operating a drone outside of these guidelines may result in legal issues. Zero-X takes no responsibility for operation of this product outside of what is legally permissible in your area.

- Do not fly your Maverick any closer than 30 metres from people, animals or buildings. Check to make sure you are no closer than 5.5 kilometres from any airfields or airports. For more information on CASA's Australian legislation visit: <http://www.casa.gov.au/>
- For information outside Australia please visit the website of your local aviation authority.
- Do not attempt to modify the Maverick or any of its components in any way, doing so will void your warranty and may affect the operation of the drone.
- Do not use the Maverick in any conditions that could affect, damage or impair your view of the Maverick including rain, wind, snow, fog or low light. Avoid getting your Maverick wet, dusty or sandy. These elements will damage the components of your Maverick.
- Please do not attempt to touch the Maverick when the Remote Control is powered on, or if the rotor blades are turning.
- When flying your Maverick, please keep in mind the privacy of others.

IMPORTANT INFORMATION - PLEASE READ BEFORE USE

1.3 BATTERY SAFETY

When handled incorrectly, Lithium polymer batteries can be dangerous and can potentially harm and do damage to persons or property. Zero-X does not accept any liability for damage to persons or property if the battery is not correctly charged, stored or protected.

- Always unwind all cables before charging.
- Do not over charge the battery. Once the charging process is completed, remove the battery from the charger as soon as possible.
- Only use the included or replacement Zero-X Maverick chargers and batteries.
- You must charge the Lithium polymer battery in a safe area away from flammable materials.
- The battery is only to be charged under adult supervision, do not leave charging batteries unattended. You should always remain in constant observation to monitor the charging process and react immediately to any potential problems that may occur.
- Do not charge the battery in temperatures hotter than 40°C or colder than 0°C.
- Do not cover the batteries when charging. Do not leave batteries in direct sunlight.
- After each flight & or crash, please check battery for any damage or swelling.
- If the battery is damaged, leaking, making noise, punctured or malformed in any way DO NOT attempt to use it. Please dispose of the battery immediately and safely in the correct manner.
- Do not bend, puncture, crush or scratch the drone's battery. Do not store batteries in your pockets, on your person or in extreme temperatures.
- After flying/discharging the battery you must allow it to cool to ambient room temperature before recharging.
- If at any time during the charge or discharge process the battery begins to balloon or swell, discontinue charging or discharging immediately. Quickly and safely disconnect the battery, then place it in a safe, open area away from flammable materials to observe it for at least 15 minutes. Continuing to charge or discharge a battery that has begun to balloon or swell can result in a fire. A battery that has ballooned or swollen even a small amount must be removed from service completely.
- Never plug in a battery and leave it to charge unattended overnight
- Non-compliance with the above warnings may result in the failure of the battery.

2.0 PACKAGE CONTENTS

1. Maverick Drone
2. Remote Control
3. Legs x 4
4. Rotor Blades x 4
5. Battery
6. Charger
7. Rotor Guards x 4
8. Camera
9. Phone Holder
10. Camera Mount
11. Camera Battery
12. AC Power supply
13. Rotor caps x 4
14. Manual
15. Metal Pins x 4
16. Locking caps x 4
17. Protective stem tops

2.1 MAVERICK OVERVIEW

1. Rotor blades
2. Lights
3. Battery hatch
4. Power switch
5. Camera mount
6. Antenna connection
7. Legs

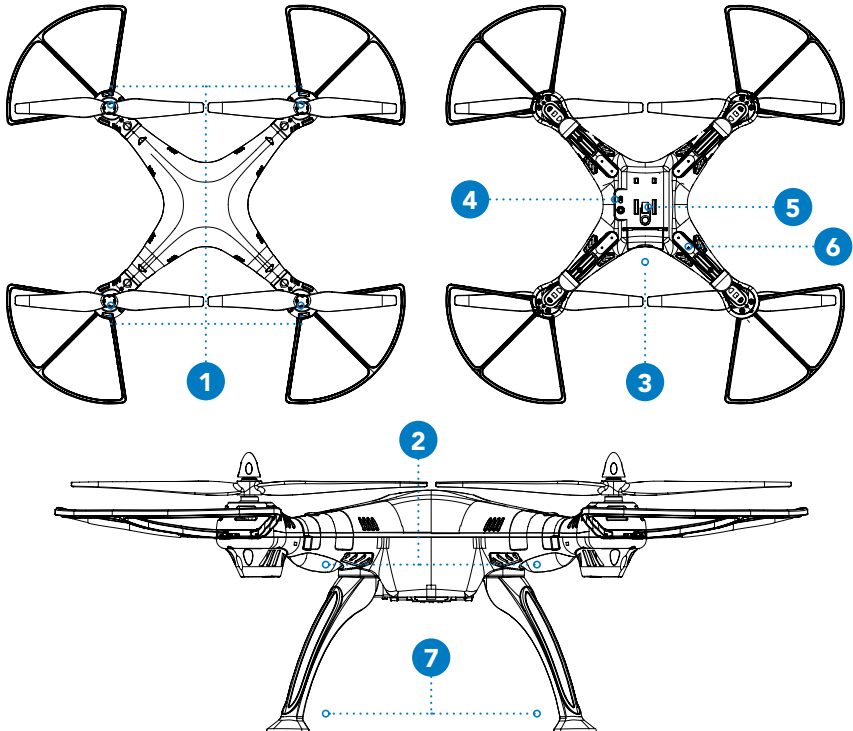

2.2 CONTROLLER OVERVIEW

1. Photo/Video button
2. Speed select/
Emergency stop button
3. Left Thumbstick
(Yaw/Elevation Descent)
4. Return to home/
Orientation Lock
5. Trim Yaw
6. Power Button
7. GPS switch
8. Landing button
9. Right Thumbstick
(Pitch/Roll)
10. Trim Pitch
11. Trim Roll

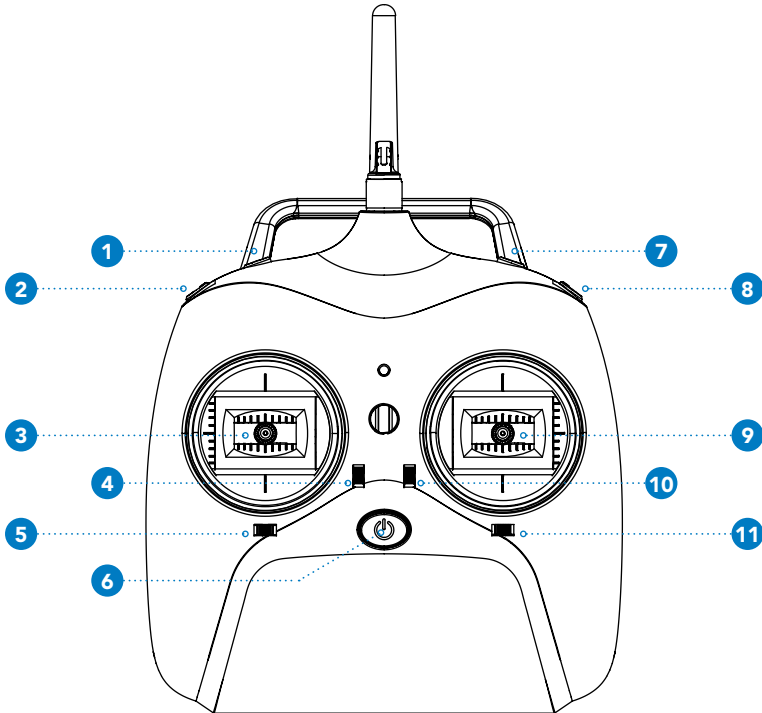

3.0 SETTING UP YOUR ZERO-X MAVERICK

3.1 CHARGING THE BATTERY

YOUR ZERO-X DRONE COMES WITH A CERTIFIED ZERO-X USB AC CHARGING ADAPTER FOR 240v CHARGING OF YOUR DRONE BATTERY. USE OF A NON ZERO-X CERTIFIED USB AC CHARGING ADAPTER WILL VOID YOUR WARRANTY AND MAY DAMAGE BOTH YOUR BATTERY AND DRONE.

Fully unwind the included USB charging cable and plug the USB end into the included Zero-X Certified USB AC charging adapter. When connected to a charging source the LED light in the charger will turn off. Connect the drone battery to the charging cable the light on the USB charging cable will glow red indicating charging is in process. The light on the USB charging cable will turn off again once charging is complete. To keep the battery life as long as possible avoid removing the battery from the charging cable before charging is complete. If you have just finished flying your Maverick drone, please allow the battery to cool down for at least 30 minutes before recharging.

1. Remove your battery from your Maverick drone making sure you have allowed 30 minutes after using the battery to allow the battery to cool down.
2. Connect the USB charging cable to the Supplied Zero-X AC charger and connect the Ac charger to a power outlet.
3. Connect your Zero-X Maverick drone battery's small white connection to the USB charging cable.
4. The battery will start charging.
5. The Maverick battery may take up to 4 hours to charge.
6. Once charging is complete remove the battery from the charger as soon as possible. Please do not leave the battery on the charger after charging is complete.

3.2 INSTALLING THE BATTERY

1. Making sure the controller is switched off open the battery hatch on the rear of the Maverick Drone and slot the battery in with the cables facing outward.
2. Connect the battery red connection to the drones red connection ensuring that the battery's red cable lines up with the drones red cable, and the drones black cable lines up to the battery's black cable.
3. Close the battery hatch making sure not to pinch any of the cables.

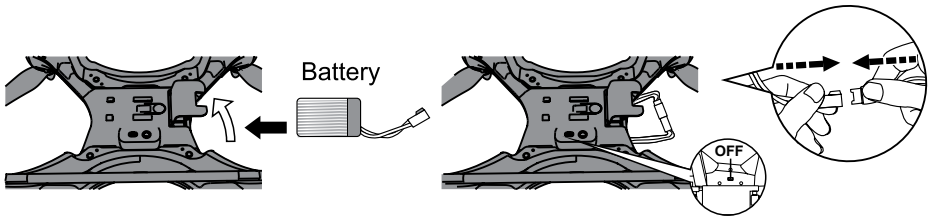

3.3 CHARGING THE CAMERA BATTERY

The Maverick drone comes with an external 1080P WiFi camera. This camera needs to be charged separate to the Maverick Drone Battery.

The camera is charged via Micro USB.

To charge the camera, please follow the instructions below.

1. Remove the camera from the camera clip on the underside of the Maverick drone.
2. Using the included USB Zero-X AC adapted and a Micro USB cable (not included) connect the USB ac adapter to your Micro USB cable.
3. Connect the AC adapter to your power supply.
4. Connect the camera to your powered Micro USB cable and allow up to 90 minutes to charge.
5. Once the camera is charged, remove the camera from the connection as soon as possible.

3.4 SECURING THE MAVERICKS LEGS

There are 4 legs included with the Maverick, one of which contains an antenna which is necessary to be connected before flying.

To connect the legs to the maverick please follow the instructions below.

1. Find the leg that contains the antenna and post the antenna cable from the drone through the hole in the top of the leg.
2. Connect the antenna to the antenna cable being careful to make sure that the pins align.
3. Place the legs peg into the socket on the drone and secure with 2 of the provided screws.
4. Place the remaining legs in position on the underside of the drone by inserting the legs pegs into the sockets and securing each leg with two of the included screws,

3.5 SECURING THE MAVERICKS BLADES

The blades on the maverick are secured by a pin and cap locking system that keep the blades in position.

To install the Mavericks rotor blades please follow the instructions below.

1. Slot the rotor blades onto the correct motor stems matching the 'A' clockwise motors with the rotor blades marked 'A' and the 'B' counter clockwise motors with the rotor blades marked 'B'. Make sure that the letters A and B on the rotor blades are facing upward.

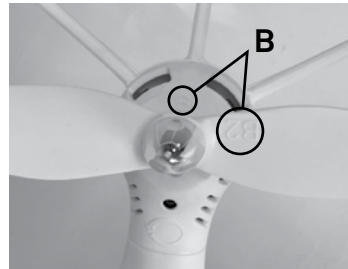

2. Make sure that the blades are secure and the hexagonal sockets on the rotor blades.
3. Slot the small white locking caps onto the motor stems on top of the rotor blades with the open larger side of the caps facing upward.
4. At this point make sure the Maverick is on a clear level surface.
5. Line the ridges in the top of the locking caps up with the holes in the motor stems and insert the included metal pins through the motor stems via the larger ridge in the locking cap. The pins should rest halfway through the motor stems.



Do not lift the drone beyond this point until the metal pins are locked in place to avoid the metal pins coming loose.

6. One at a time, gently lift the white locking caps until the pin is pressed against the floor of the locking cap and twist the locking cap so the pin passes underneath the locking lip of the locking cap. The pin will click into position when the cap is turned 90° and the pin is halfway under the caps locking lip.



7. Finally press the protective stem tops onto the motor stems so that the locking system is covered.

The protective stem tops will not touch the rotor blades.

4.0 REMOTE CONTROL

1. Ensure that the remote control is turned off.
2. Remove the battery cover on the rear of the remote by sliding it downward.
3. Insert 6 AA batteries into the battery hatch on the rear of the controller.

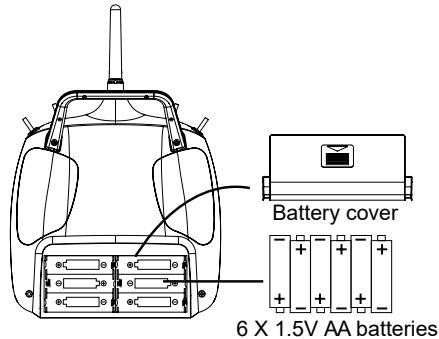

4. Replace the battery cover on the rear of the controller by sliding it upward.

Note:

Please ensure the batteries that you are using are all the same brand and are all fully charged when you use them. Using batteries that have varying levels of charge will affect the controller's performance.

4.1 INSTALLING A MICRO SD CARD

The Maverick includes a 1080P WiFi camera which is attached to the underside of the drone.

To record with this camera, it is required that a Micro SD card is inserted into the camera.

To insert a Micro SD card in the camera please follow the instructions below.

1. Remove the camera from the camera clip on the underside of the drone.
2. While facing the camera's screen, there is a Micro SD Card slot on the left side of the drone. Take your Micro SD Card and insert it into the Micro SD Card slot with the text side of the card facing towards the screen.

3. Using your thumbnail press the Micro SD card into the slot until a click is heard.

Note:

Micro SD Card is not included.

A class 10 Micro SD Card up to 32GB is recommended.

The Camera also needs to be charged separately to the Maverick drone. For instructions on charging the camera battery please see section CHARGING THE CAMERA BATTERY (Page 6).

5.0 LAUNCH SEQUENCE

To launch your Maverick drone, it is important that the drone battery is fully charged and the controller batteries have a good amount of charge.

It is also important to check over the rotor blades to ensure that they are securely installed as per the instructions laid out in the SECURING THE MAVERICKS BLADES section of this manual and the Mavericks legs are also correctly secured.

If you intend to record your flight using the included camera, it is important that the camera is charged and you have inserted suitable Micro SD Card in the camera.

Please calibrate your Maverick drone using the below instructions each time before launching, this will assist in keeping the drone and it's GPS stable.

To Launch the Maverick drone please read through all instructions before attempting to take off.

5.1 CALIBRATING THE MAVERICK

1. Ensure the Drone and camera batteries are fully charged and installed and the controller batteries are of an adequate level and conduct a complete check of your surroundings making sure that your flight area is free of any hazards.
2. Hold the button on the controller for 2 seconds until it switches on.

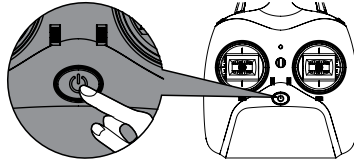

3. Switch the power switch on the underside of the Maverick on and place on a level section of ground free of any obstacles.

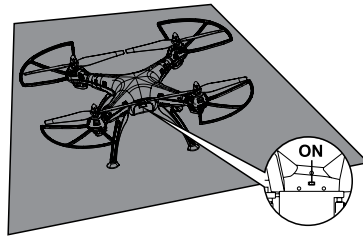

4. At this point if you intend to film your flight turn on the camera by holding the button on the front face of the camera for 1 second and when the camera powers up press the OK button on the top of the camera and recording will start.
5. Move the GPS switch on the top right of the controller to the back position turning it off.

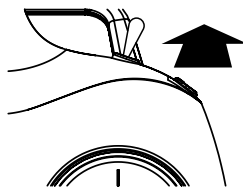

6. Move the left thumb stick to the top upward position for 1 second then move the right thumb stick to the lowest downward position for 1 second and then bring the thumb stick back to the middle neutral position.

This will bind the controller and the drone. The lights on the underside of the drone will glow solid indicating that binding is successful.

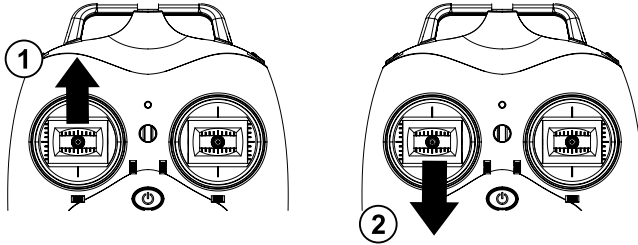

7. To begin horizontal calibration, hold the left thumb stick upward for 3 seconds until the controller beeps and the lights start flashing. Once horizontal calibration is activated pick the Maverick drone up and rotate it horizontally clockwise until the lights stop flashing.

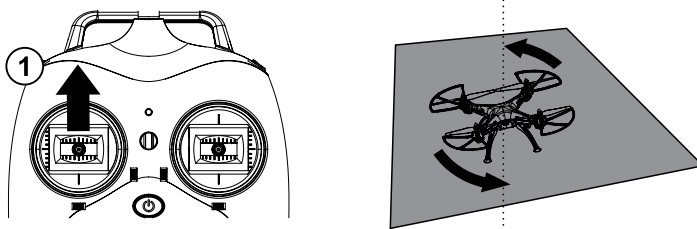

8. To begin vertical calibration, hold the left thumb stick downward for 3 seconds until the controller beeps and the lights start flashing. Once the vertical calibration is activated pick the Maverick drone up and turn it on its side. With the drone on its side rotate the drone on its vertical axis continuously until the lights stop flashing and the calibration completes.

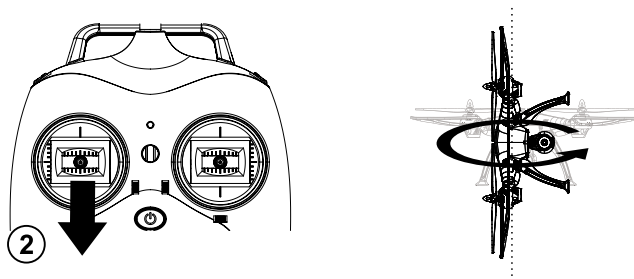

9. Place the Drone back on the level ground and switch the controller off by holding the controller power button for 3 seconds.
10. Power up the controller by holding the power button for 1 second.
11. Rebind the controller to the drone by holding the controllers left thumb stick in the upward position for 1 second and then move and hold it in the downward position for 1 second. The Mavericks lights should stop flashing indicating the controller has been bound.

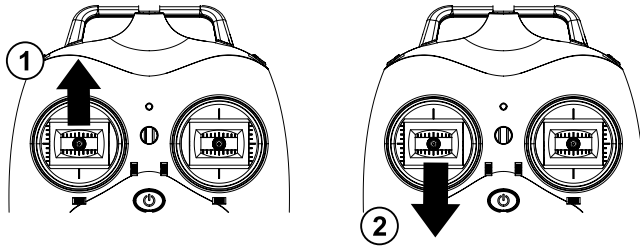

12. Switch the GPS switch forward (On) and then backward (Off) to activate GPS and compass calibration mode.

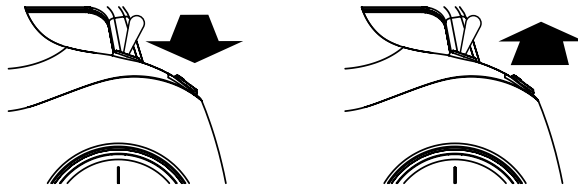

13. To lock the Mavericks Compass settings, hold both the left and right thumbs in the bottom left position for 4 seconds.

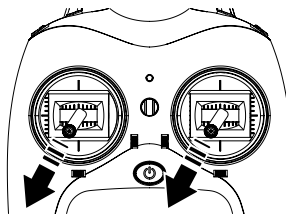

14. To lock the Mavericks home GPS position, hold the left and right thumb sticks in the bottom right position for 4 seconds. (This is crucial when using the drones return to home function).

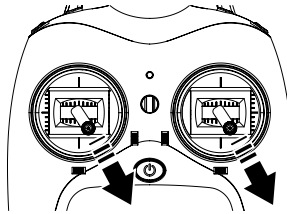

15. Switch the GPS switch on the remote controller forward switching GPS on.

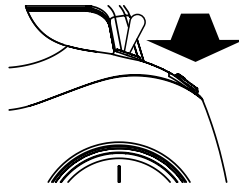

16. Finally, to unlock the drones motors, simultaneously hold the left thumb stick in the bottom left position while holding the right thumb stick in the bottom right position for two seconds until the drones rotor blades start spinning.

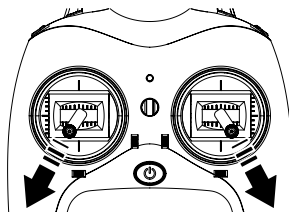

17. Move the left thumb stick upward within 5 seconds while at a safe distance (approx. 5M) to launch the Maverick.

5.2 QUICK LAUNCH

To quick launch the drone you **MUST** first go through the 'Calibrating the Maverick' process in each flying session before attempting to quick launch.

Failing to do so may result in unstable flight and the GPS module to become inaccurate.

1. While holding the left thumb stick in the downward position switch the controller on by holding the power button for 1 second.

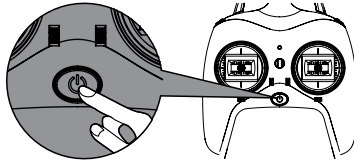

2. Switch The drones power switch on and place it on flat level ground ensuring that there are no obstacles near the drone. The drone's lights will flash rapidly waiting for the controller to be bound.

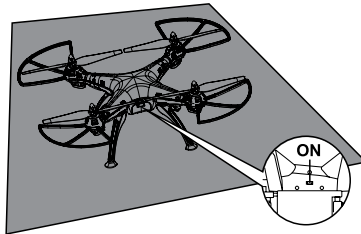

3. At this point if you intend to film your flight turn on the camera by holding the button on the front face of the camera for 1 second and when the camera powers up press the OK button on the top of the camera and recording will start.
4. Move back so you are a safe distance from the drone (5M).

- Bind the controller to the Maverick by holding the left thumb stick in the upward position for 1 second then hold the Left thumb stick in the downward position for one second. When the controller beeps and the lights on the arms of the drone stop flashing the controller and drone have been bound. Release the left thumb stick allowing it to return to the neutral position.

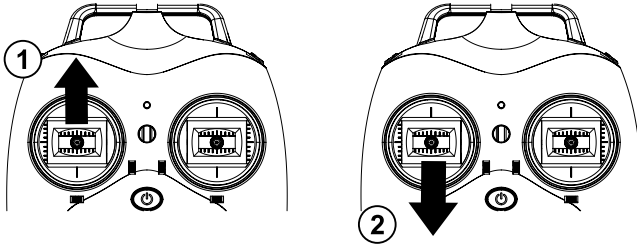

- Unlock the motors by simultaneously holding the left thumb stick in the downward left position while also holding the right thumb stick in the downward right position.

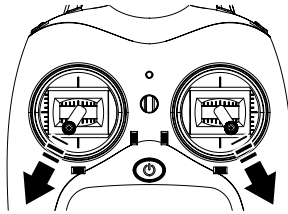

- The motors will now start, to launch the drone push the left thumb stick upward within 5 seconds of the motors being unlocked.

6.0 BASIC FLIGHT

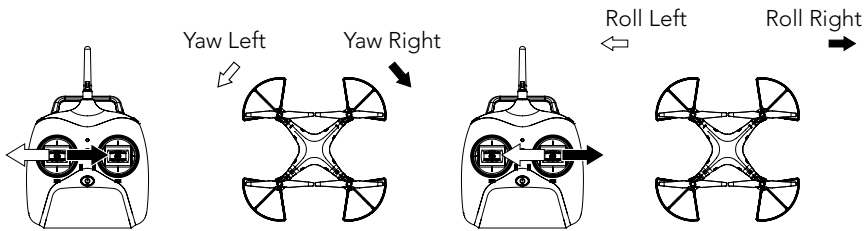
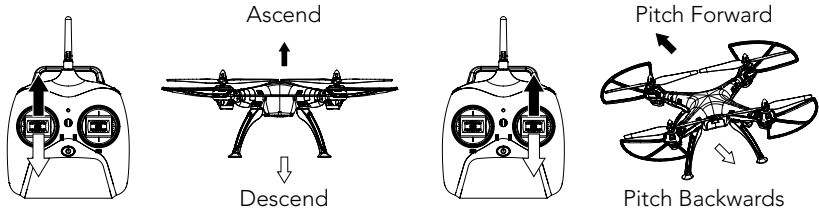

6.1 SPEED MODES

The Maverick has 3 speed modes that control the acceleration and maneuverability of the drone. To cycle through the Speed Modes, use the Speed Button on the top left of the controller.

LOW

When the Maverick is powered up it will start in LOW speed mode. In this mode, the Maverick will control and fly slowly. It is advised that beginners use this mode to learn the basics before moving onto the two higher modes.

MID

Push the Speed Button once and the Remote Control will beep twice indicating that the Maverick is now in the medium Speed Mode. In this mode, the sensitivity of both the acceleration, and directional control of the Maverick will be increased, making the Maverick more nimble.

HIGH

Push the Speed Button a second time and the Remote Control will beep three times indicating that the Maverick is now in its highest Speed Mode. In this mode, the sensitivity of both the acceleration and directional control will be increased again. It is advised that this mode is only used in a very open space once the pilot has gained significant drone flight experience.

6.2 TRIMMING

Trimming is used to balance the Maverick when flight is off centred. Please check before attempting to use trimming that the Maverick's flight is not being affected by outside forces such as wind.

To trim the Maverick's pitch, use the Pitch Trim Controller which is the small switch on the Remote Control to the left of the Right Thumb stick. This will balance the forward and back movement of the Maverick.

To trim the Maverick's roll, use the Roll Trim Controller which is the small switch on the Remote Control below the Right Thumb stick. This will balance the left and right movement of the Maverick.

To trim the Maverick's roll, use the Roll Trim Controller which is the small switch on the Remote Control below the Right Thumb stick. This will balance the left and right movement of the Maverick.

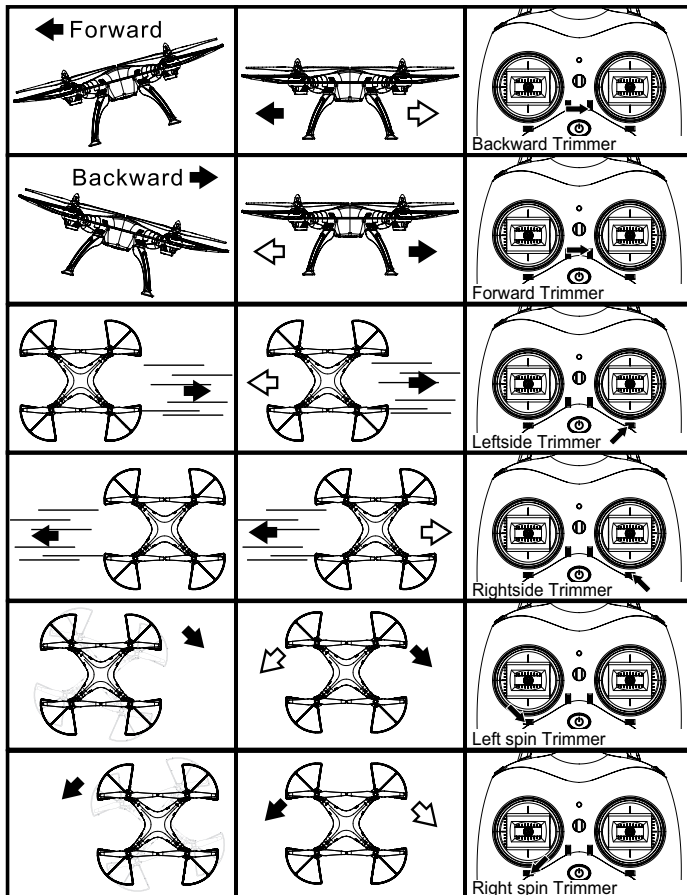

6.3 GPS

The Maverick drone uses GPS to position itself keeping the drone steady in the air.

Once it has positioned itself the GPS also helps bring the Maverick back to your launching position.

It is important to calibrate the drone before each flight making sure to lock the Mavericks home position before launching to ensure that the Maverick drone returns to the correct position each time.

To activate the GPS function switch the GPS switch forward.

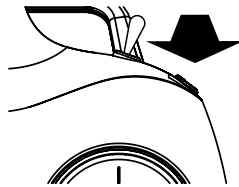

To deactivate the GPS function switch the GPS switch back.

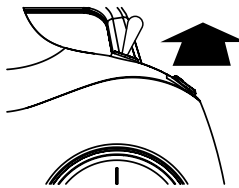

6.4 RETURN TO HOME

The return to home function brings the Maverick drone back to the launch position.

To activate return to home GPS must be active.

For the return to home function to work it is important to calibrate the Maverick before each flight using the instructions laid out in the Calibrating the Maverick section of this manual.

Activating this function without calibrating the drone may result in the drone flying away.

To activate return to home push the switch to the right of the left thumb stick down.

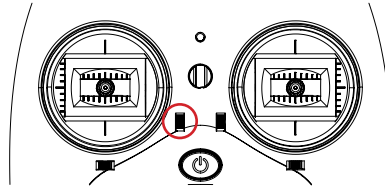

The drone will begin to return to within 10M of the launch position.

To cancel the return to home function resume controlling the drone using the thumb sticks.

6.5 DIRECTIONAL LOCK MODE

Directional Lock mode is a mode that makes it easy for beginners to fly. In this mode the direction you and the Maverick are facing when the Maverick is launched will always be forward on the controls, no matter which way the Maverick is facing. This means that even if you can't see which way the Maverick is facing you will be able to bring the drone back towards yourself by pulling back on the Right thumb stick (Pitch/Roll).

1. After powering up the Maverick and pairing with the controller (see section 'Launch Sequence') ensure that you and the Maverick are facing the same direction.
2. Activate Directional Lock by switching switch to the right of the left thumb stick once and the lights on the Maverick will flash indicating that the drone is now in Directional Lock mode. It is important that you do not change the orientation position you are standing in when you activate Directional Lock as this will affect the control of the drone.
3. You will now be able to fly the Maverick in Directional Lock mode.
4. To exit Directional Lock mode, push the Directional Lock again and the Maverick lights will shine solid again.

6.6 EMERGENCY LANDING

Emergency landing is only to be performed in an emergency.

When emergency is activated the rotor blades will lock and the drone will fall to the ground.

To activate emergency landing push the button on the top left of the controller.

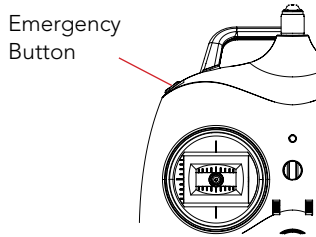

It is highly recommended that you do not push this button unless it is an emergency.

7.0 CAMERA

The camera included with the Zero-X Maverick will shoot 1080P video of your flight.

The camera needs to be charged and have a suitable Micro SD Card installed.

For camera charging instructions please see the section of this manual marked Charging the Camera battery.

For instructions in installing a Micro SD Card please see the section of this manual marked Installing a Micro SD Card.

To switch the camera on hold the power button on the front face of the camera for 1 second.

The camera will power up and be ready to record.

7.1 CAMERA INSTALLATION

To install the camera attach the camera please follow the instructions below.

1. Attach the camera clip to the drone by slotting it into the place making sure the open side clip is facing forward.
2. Make sure the camera mount is secure and the locking bolt is tight.
3. Clip the camera into place insuring it is secure.

7.2 RECORDING VIDEO

While the camera is powered up, recording can be activated by pressing the OK button on the top of the camera or via the APP via the cameras WiFi connection. Please be aware that the camera's WiFi range is 30M. When a recording is activated via WiFi, the camera will continue recording even if the drone leaves WiFi range.

7.3 REVIEWING VIDEO

The best and easiest way to review your recorded footage is to remove the Micro SD Card from the drone and connect it to your computer via a Micro SD Card Reader.

7.4 WIFI

The cameras WiFi ability allows you to wirelessly connect your smartphone to the Maverick, using the Zero-X Maverick App.

The Cameras WiFi can be activated by powering up the camera and then pushing the Up button on the side of the camera.

The camera will now display the connection name and the password to connect to the camera. The default connection name and password is.

SSID: ZEROX00000000

PASSWORD: 12345

The connection name and password can be customised in the cameras settings menu.

To connect to the camera via WiFi please follow the instructions below.

1. Download the Zero-X Maverick App onto your smartphone from either the Google Play store or Apple App Store.
2. Once downloaded, power up the camera by holding the power button on the front face of the camera for 1 second.
3. When the camera is powered up press the UP button on the right side of the camera.
4. The camera screen will now display the Connection Name and Password.
5. On your smartphone open the WiFi Settings and connect to the cameras connection.
6. Use the password given on the cameras screen to access the cameras connection.
7. Once connected open the Zero-X Maverick app on your smartphone.
8. You will now be able to use your smartphone as a viewfinder as well as activate recordings and transfer your existing recordings to your smartphone.

Please note that the range of the cameras WiFi is 30M, if a recording is active it will continue to record after the drone has left the 30M range.

7.5 MOUNTING YOUR SMART PHONE

To mount your smartphone on the controller please follow the instructions below

1. Unscrew the screws on the antenna loop on the included smartphone holder.
2. Put either side of the antenna loop around the controllers antenna making sure that the lip on the antenna is secure inside the antenna loop.
3. Secure the loop again with the screws that were removed in step one.

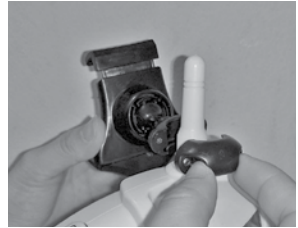

8.0 DRONE MAINTENANCE

Avoid exposing your Maverick and its accessories to dust, sand and moisture as these can damage the Maverick. If the Maverick is exposed to dust or sand, use a soft brush to remove any visible particles.



8.1 REPLACEMENT PARTS

We understand that it's not always easy learning how to fly a drone, and sometimes a close call can turn into a crash landing. To thank you for your support of Zero-X purchase and to help you build your confidence in learning how to fly your drone we want to offer you 50% off your first order of any spare parts by using the code below on www.zero-x.com.au. There you will be able to find and buy the spare parts listed below.

- Battery
- Counter Clockwise Motor
- Clockwise Motor
- Rotor guards

THANK YOU FOR YOUR SUPPORT!
PLEASE VISIT OUR WEBSITE &
USE PROMO CODE:
OOPSIBROKEIT
to receive
50% OFF
your spare parts purchase!

THANK YOU FOR YOUR SUPPORT!
PLEASE VISIT OUR WEBSITE &
USE PROMO CODE:
OOPSIBROKEITAGAIN
to receive
50% OFF
your spare parts purchase!

9.0 WARRANTY TERMS & CONDITIONS

Our goods come with guarantees that cannot be excluded under the Australian and New Zealand Consumer Law. You are entitled to a replacement or refund for a major failure and for compensation for any other reasonably foreseeable loss or damage. You are also entitled to have the goods repaired or replaced if the goods fail to be of acceptable quality and the failure does not amount to a major failure.

This warranty is provided in addition to your rights under the Australian & New Zealand Consumer Law.

Zero-X warrants that this product is free from defects in material and workmanship for a period of 12 months from the date of purchase or for the period stated on the packaging. This warranty is only valid where you have used the product in accordance with any recommendations or instructions provided by Zero-X.

This warranty excludes defects resulting from alterations of the product, accident, misuse, abuse or neglect.

In order to claim the warranty, you must return the product to the retailer from which it was purchased or if that retailer is part of a National network, a store within that chain, along with satisfactory proof of purchase. The retailer will then return the goods to Zero-X. Zero-X will repair, replace or refurbish the product at its discretion. The retailer will contact you when the product is ready for collection. All costs involved in claiming this warranty, including the cost of the retailer sending the product to Zero-X, will be borne by you.

Zero-X Address: 33 Quinn Drive, Keilor Park ,Victoria 3042 Australia

Ph: +61 03 8331 4800 **Email:** service@zero-x.com.au

NOTES

_maverick

Capture the skies.™

ZERO-X

www.zero-x.com.au | www.zero-x.co.nz



All Images, Information and Content are
Copyright © 2018 Directed ANZ Pty Ltd.
All Rights Reserved.

© Zero-X v2.0 2018